

The HDS6 half crystal can size, 2 pole changeover relay has been in U.K. production longer than any other comparable relay. Its all welded construction dynamically balanced armature, argon-arc welded seal and special resonance free contact system ensure satisfactory performance under extreme environmental conditions

The finished relay is contaminant free; assured by ultrasonic cleaning, vacuum de-gassing, sealing into a stainless steel can by argon arc welding and filling of the relay enclosure with inert dry nitrogen.

Special relays are available with coil transient suppression incorporated by the fitting of diodes. In this case polarity has to be observed when connecting the relay into circuit and this is indicated by the reference HDP6. As a result of incorporating diodes in this way release time, weight and overall height are slightly increased.

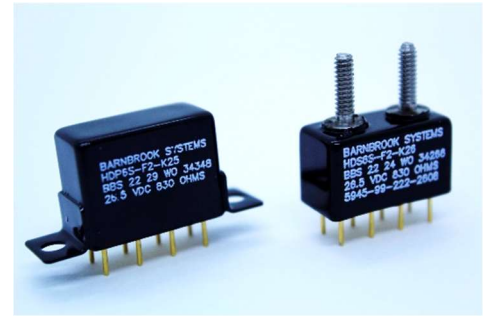

TYPE HDS6 & HDP6

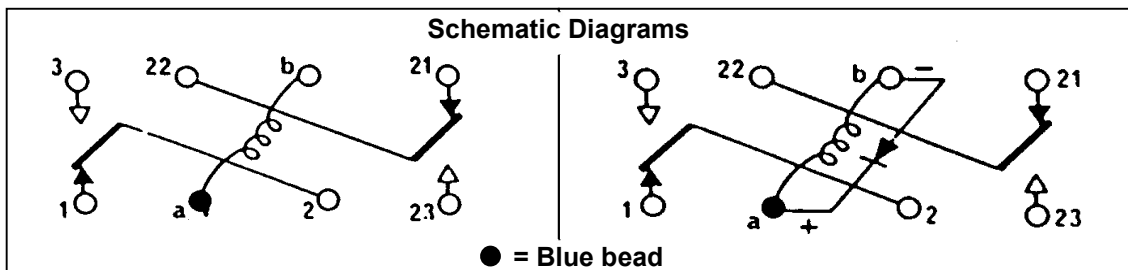

Technical Data

Standard Relay Identification

Letter

Contact Form
Contact Material
Contact Rating/Life

K

2 Pole changeover (2PDT)
Gold plated silver alloy
2 Amps at 28 VDC resistive load, 10^5 operations
4 Amps at 28 VDC resistive, 10^4 operations.
1 Amp at 28 VDC, 400 Hz resistive load, 10^5 operations
(case ungrounded)
Low level, 10^6 operations

Contact Resistance
Operate Time
Release Time

50 mΩ initial, 100 mΩ after rated life
4 ms max at 25°C with nominal voltage.
4 ms max at 25°C with nominal voltage.
(not applicable to HDP6)

Bounce Time
Insulation Resistance
Dielectric Strength

3 ms max.
Not less than 500 MΩ at 500 Volts.
750 VRMS at 50 Hz except 500 VRMS between open contacts and coil to case at sea level. 350 VRMS at 70,000 ft.

Capacitance

Between open contacts 0.38 pF
Between normally open contacts and case 1.50 pF
Between normally closed contacts and case 2.50 pF
Between contact sets 0.30 pF
Between coil and case 22.00 pF

Data Sheet No
DSHDS6- 3922

SHEET 1 OF 4

Design authority and manufacture by Barnbrook Systems Limited
Barnbrook Systems reserves the right to alter specifications and design without notice

| | |
|-------------------|--|
| Temperature Range | -65°C to +125°C Ambient |
| Vibration | 0.33 inch DA, 5 - 35 Hz, 20g, 35 – 3000 Hz. |
| Shock | 50g, 11 milliseconds |
| Weight | HDS6 – 10 gm. Max (Style 21, other styles vary with brackets etc.) |
| Dimensions | See drawings on page 3 |
| Coil Data | Minimum operate power – 220 milliwatts Power dissipation at nominal voltage – 800 milliwatts Maximum Permissible Coil Dissipation – 1.4 watts at 25°C 1.0 watt at 125°C |

| Standard Coil | H2 | C2 | E2 | M2 | F2 | J2 | G2 |
|---------------------------------------|-----|-----|------|-----|------|------|------|
| Nominal Operate voltage, VDC | 4.5 | 6.3 | 12.6 | 18 | 26.5 | 32 | 48 |
| Coil Resistance, ohms +/- 10% at 25°C | 25 | 42 | 210 | 430 | 830 | 1300 | 2800 |
| Maximum Pull-in voltage at 25°C | 2.5 | 3.2 | 6.8 | 9.5 | 13.5 | 16.8 | 25.5 |
| Minimum Drop-out voltage at 25°C | 0.2 | 0.3 | 0.6 | 1.1 | 1.0 | 1.4 | 2.5 |

| | |
|-----------------------------------|--|
| Mountings and Terminations | Details of standard mounting brackets, studs etc, and terminations are given on page 3. Sockets are available for 'plug in' fitting. |
| Finish | The stainless steel can is finished with a black epoxy paint. Identification is in white indelible ink. HDS6 header and terminals are hot tin dipped. |
| Special Modifications | To contacts, operating characteristics, mountings, terminations, finish etc., may be obtained to special order. If your requirements are not satisfied by a standard relay consult your Barnbrook representative or contact our Sales Office. |
| HDP6 | This is a HDS6 relay respectively with diodes fitted to provide suppression of the transient back EMF which occurs when the relay is de-energised. The diodes used are of a type which will withstand the same arduous conditions as the relay in order that performance shall not be impaired. Note that release time is increased to 8 milliseconds and overall height of the relay is increased to 0.600 in. Suppression is such that the back EMF does not exceed 5V. |

Data Sheet No
DSHDS6- 3922

SHEET 2 OF 4

DIMENSIONS AND MOUNTING STYLES

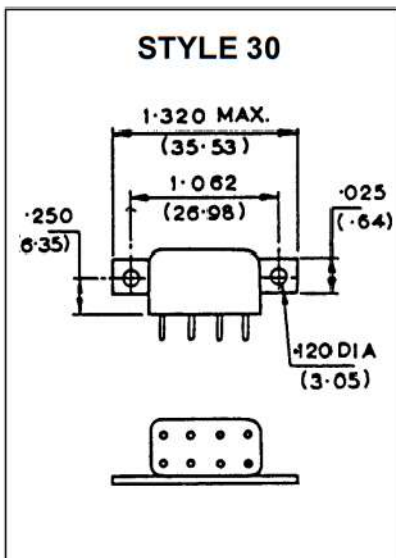
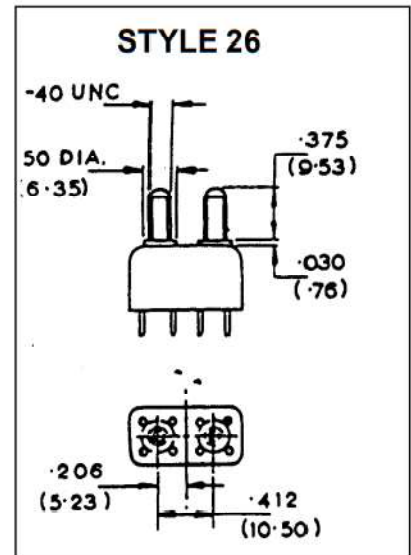
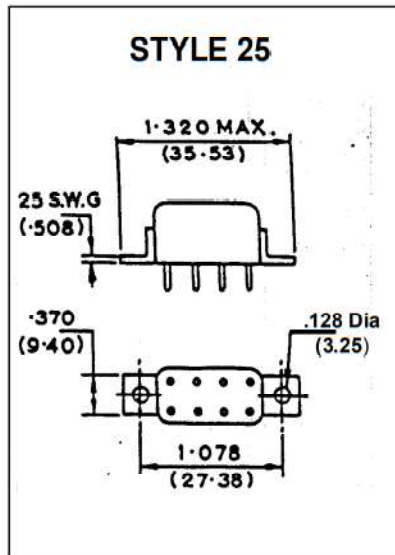
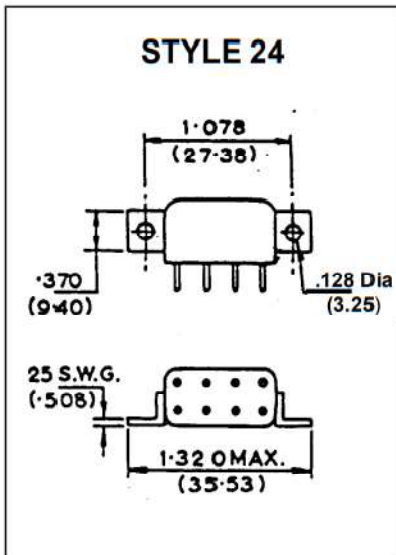
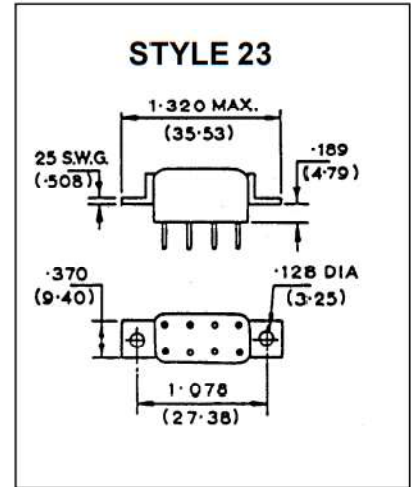
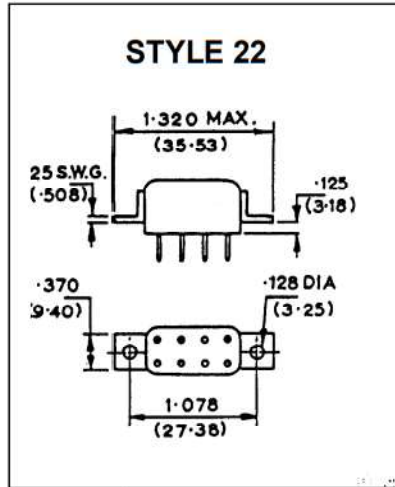
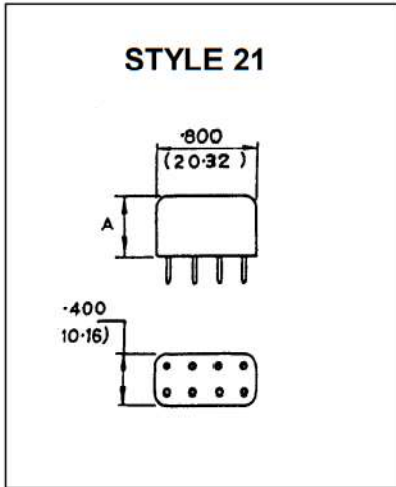

| Relay Type | Dimension 'A' | |
|------------|---------------|-------|
| | In. | mm |
| HDS6 | 0.460 | 11.68 |
| HDP6 | 0.600 | 15.30 |

Notes :

1. Dimensions in brackets are millimetres.
2. Dimensions shown in style 21 are applicable to all styles.
3. This is a selection of mounting styles in common use. Alternative styles are available. If your requirements are not met by one of those shown please contact our Sales Department.

Data Sheet No
DSHDS6- 3922

SHEET 3 OF 4

ORDERING INFORMATION

HDS6S - F2 - K22

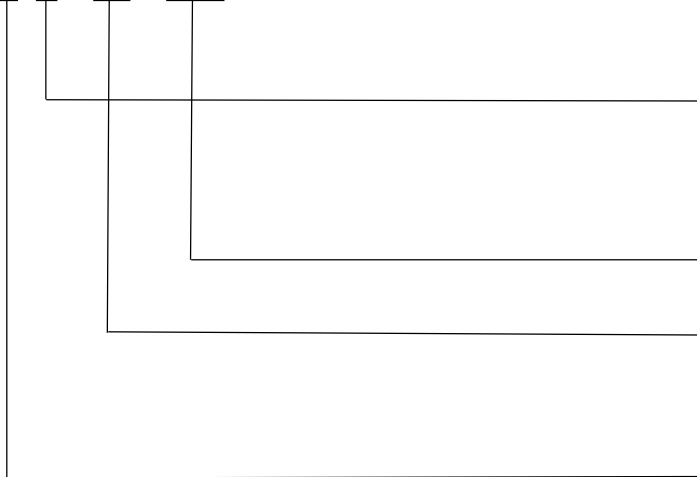

Termination Variant
(Refer to Table Below)

Mounting Variant
(Refer to Page 3)

Coil Variant
(Refer to Page 2)

Identification Variant

S = Standard

P = Coil Transient Protection

TERMINATION VARIANTS

| HD Style | Type | Dim. X in mm. |
|----------|----------|---------------|
| A | Straight | 7.92 |
| B | Straight | 12.70 |
| C | Straight | 25.40 |
| H | Hooks | 5.08 |
| L | Straight | 76.20 |
| S | Straight | 5.08 |

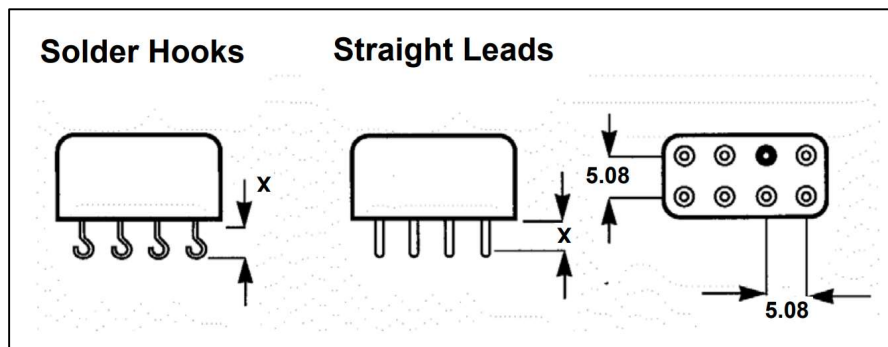

Data Sheet No
DSHDS6- 3922

SHEET 4 OF 4